

# **JAHNS**

---

## HYDRAULIK

### Multi-chamber volumetric-divider **MZB**

edition 12.03

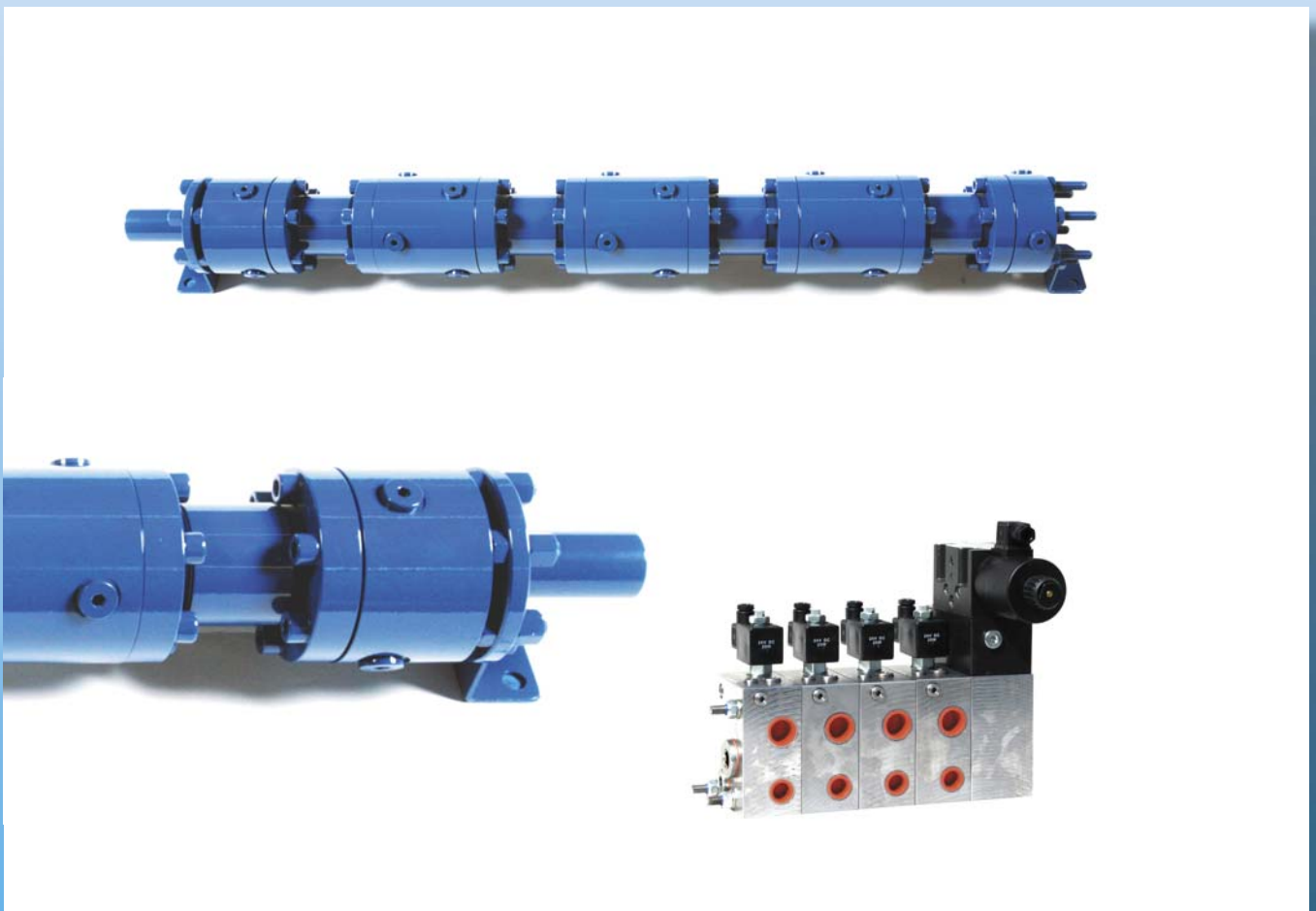

**Jahns-Regulatoren GmbH**

D 63069 Offenbach

D 63009 Offenbach

<http://www.jahns-hydraulik.de>

Sprendlinger Landstraße 150

Postbox 10 09 52

Telephon +49 (0)69 848477-0

Telefax +49 (0)69 84847725

[info@jahns-hydraulik.de](mailto:info@jahns-hydraulik.de)

# Contents

---

Construction type, method of operation, synchronus operation .....	3
Application, dimensions.....	3
Design, piston rod on both sides, DMS .....	4
Position measuring systems, hydraulic fluid, mounting position .....	4
Speed, Operating noise, connections, pressure drop .....	4
B29 manifold, storage, installation .....	5
Commissioning, maintenance .....	5
Multi-chamber volumetric-divider <b>MZB-050</b> .....	6, 7
Multi-chamber volumetric-divider <b>MZB-080</b> .....	8, 9
Multi-chamber volumetric-divider <b>MZB-140</b> .....	10, 11
Multi-chamber volumetric-divider <b>MZB-180</b> .....	12, 13
Multi-chamber volumetric-divider <b>MZB-220</b> .....	14, 15
Multi-chamber volumetric-divider <b>MZB-280</b> .....	16, 17
Manifold <b>B29-140 NG6</b> and <b>NG10</b> .....	18, 19
Manifold <b>B29</b> , hydraulic diagram.....	20, 21

© Jahns Regulatoren GmbH 2004, 2007, 2012, 2013, 2015, 2017

Reprinting, even partially, not permitted.

No responsibility for possible errors in catalogues or other printed material is accepted.

Former catalogues lost their validity.

Catalogues are subject to be changed.

# Multi-chamber volumetric-divider MZB

## General points

In addition to its range of piston flow divider valves, gear oil flow dividers and radial piston oil flow dividers, Jahns has supplied for many years volumetric dividers for high precision flow division, namely the linear stroke volumetric dividers of the type MLH and the MZB multi-chamber volumetric dividers which are presented in the following. The synchronisation accuracy of volumetric dividers is significantly higher than that of oil flow divider solutions.

## Construction type

MZB multi-chamber volumetric dividers differ from MLH linear stroke volumetric dividers only in terms of their construction. In principle a multi-chamber volumetric divider consists of a line of cylinders, whose pistons are attached sequentially to one continuous piston rod. The number of chambers equates to the number of cylinders they are required to operate. Each of these operating cylinders that are driven by the MZB must be of equal dimensions. Preference is given to double acting or

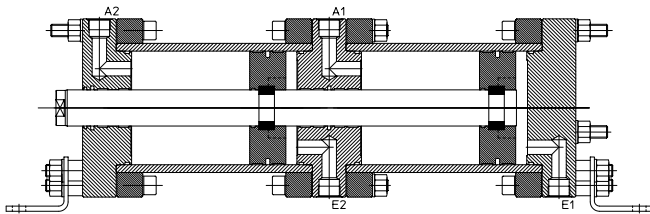

synchronous cylinders. Single acting cylinders may be possible depending on the particular construction type. Telescopic cylinders are not suitable. The volume of oil per chamber is specified as being approximately 10% higher than the volume of the operating cylinder.

## Method of operation

All the MZB's inputs are channelled through one line. One MZB output is connected to each operating cylinder. When the volumetric divider is driven the volume of oil is forced simultaneously into all operating cylinders. The volume of oil only travels between the MZB and the operating cylinders. It is possible to change the oil when required using the B29 manifold as later described.

## Synchronous operation

The aim is perfect synchronisation and this is achieved to all intents and purposes when the operating cylinders are subject to the same load. This is preconditioned on the absence of air bubbles in the oil flowing between the MZB and the operating cylinders.

Inaccuracies only result from differences in the tolerances of the cylinder components and the possibility of the cylinder seals used containing seepage oil. Due to these potential sources of error it is not possible to claim 100% synchronous operation, yet the variance from the optimum value is hardly detectable in practice.

However, consideration must be given to one error that is caused by compression of the oil when the operating cylinders are subject to quite different loads. A pressure variance of 10 bar between two operating cylinders results in a difference in travel of approx. 0.07%.

If the pressure is equal in the operating cylinders, the compression that occurs in the oil columns has no effect on the synchronous operation. It is only when unequal loads cause different pressures in the individual operating cylinders that a compression related synchronisation error occurs.

This error also remains the same during the stroke, since the fixed volume does not change. If, for example, the load distribution becomes more uniform during the stroke, this error is reduced accordingly.

## Application

Multi-chamber volumetric dividers are used primarily for:

- Precise stroke mechanisms with small oil flows
- Stroke mechanisms with the least oscillation and vibration possible (e.g. theatre stages, cylinder raising in the print industry and in heavy machinery).
- Tipping equipment

## Dimensions

Multi-chamber volumetric dividers can be manufactured with up to 12 chambers. For the standard versions the potential volume per chamber is between 150 cm<sup>3</sup> and 65.000 cm<sup>3</sup>.

The current limitation in terms of length is 6000 mm and a total weight of 2000 kg.

# Multi-chamber volumetric-divider MZB

## Design

The multi-chamber volumetric dividers are designed so that the number of chambers equates to the number of operating cylinders. They are configured according to the maximum oil velocity between the multi-chamber volumetric divider and the operating cylinders.

The distance the multi-chamber volumetric divider needs to travel and consequently the volume of oil per chamber is based on the volume of oil required by the operating cylinders. The specification is that the volume of oil in the multi-chamber volumetric divider is 10 to 15% higher than this so as to ensure that the operating cylinders are always able to travel to their end limit position and a compensatory 'reset' is not necessary after each stroke. It is important to note the minimum travel for each particular version.

It is not a disadvantage to have a larger chamber volume than that which is necessary for the operating cylinders.

## Piston rod on both sides

If requested multi-chamber volumetric dividers can be supplied with piston rods extending from both sides (e.g. to be used to activate direction control valves).

## DMS

Multi-chamber volumetric dividers can be supplied optionally with adjustable proximity sensors in a special protective casing. They come as standard with 2 switch points for minimum and maximum travel. Additional switch points can be supplied. The minimum distance between switch points is 38 mm. It is also possible to supply a version where one switch point can be switched by two proximity sensors independently of each other. In this version a smaller distance between the switch points is possible than is the case for the standard version. The proximity sensors are supplied with an open or close function.

## Position measuring systems

Multi-chamber volumetric dividers can be supplied on request with various position measuring systems.

## Hydraulic fluids

As a rule HL and HLP hydraulic oils are used for which NBR (Nitrile Butadiene Rubber) seals are fitted. For other hydraulic fluids (HFC, HFD or bio-degradable fluids) other sealing materials (such as FKM) may be necessary. When making an enquiry it is necessary to state the hydraulic fluid that will be used.

## Mounting position

The preferred mounting position is horizontal.

## Speed

With the use of low friction cylinder seals it is possible to operate the MZB extremely slowly. Stick/slip free movement is possible even with very small oil flows. The maximum oil flows are given in the tables for the respective versions.

## Operating noise

As is usual cylinders produce hardly any noise when in operation. Due to the absence of vibration or oscillation the multi-chamber volumetric divider can be employed successfully precisely in applications where such side effects are unacceptable (e.g. hospitals, theatre stages, etc.)

## Connections

Since the applications generally use minimal oil flows, it was possible to design the connections to be relatively small. Larger threaded or SAE connections can be supplied on request. However this version does affect the width of the intermediate flange and therefore also the overall length.

## Pressure drop

Pressure drops only occur when seals are impinged on both sides. At 5-7 bar, depending on respective size, these are significantly lower than is the case with radial piston oil flow dividers and gear oil flow dividers.

# Multi-chamber volumetric-divider MZB

## B29 Manifold

For multi-chamber volumetric dividers it is important to use a manifold that enables the following functions:

- the equipment to be filled when commissioning
- pressures between multi-chamber volumetric divider and the operating cylinders to be assured
- any loss of oil to be compensated 'reset'
- the oil to be changed

The B29 manifold consists of an input manifold and one segment for each chamber of the multi-chamber volumetric divider. The input manifold is fitted with a pressure reducing valve and a 4/2 directional control valve.

Each segment is equipped with a pressure limit valve for a maximum of 140 litres/min., a non-return valve, electrically switchable 2/2 directional control valve as well as a G1/4" test port.

The pressure limit valves in the B29 manifold are responsible for assuring the pressures between the multi-chamber volumetric divider and the operating cylinders.

They do not enable an end limit position compensation as it is the case for radial piston flow dividers (MTO, HTO, MT-GM, MTL and STL).

The input manifold can be supplied with NG-6 or with NG 10 valves. The larger valves make it possible to fill or replace the oil between the multi-chamber volumetric divider and the operating cylinders more quickly.

The user connects the manifold to the multi-chamber volumetric divider externally using a pipe connection.

The B29 manifold is a further advance on the previous versions B26, B27 and B28.

When using proprietary manifolds it is essential to ensure that the pressures between the multi-chamber volumetric divider and the operating cylinders meet the maximum pressure values of the multi-chamber volumetric divider at the given volumetric flow rate.

## Storage

Dry, dust and frost free storage must be ensured. It is also necessary to avoid any ingress of contamination. To prevent corrosion during longer term storage it is recommended that the volumetric divider is filled with oil. Exposed parts (e.g. piston rod) must be greased.

## Installation

When installing the multi-chamber volumetric divider maximum cleanliness must be ensured. The end caps in the connections should only be removed immediately before fitting the threaded fittings. Pipes must be free of dirt and swarf. When the connecting pipes have been welded it is essential that any scaling is completely removed before installation. Where possible the pipes should be dipped. The cylinder connections are designed for all readily available screw fittings with a cutting edge.

In addition it is essential that the volumetric divider installation is stress-free and also that unacceptable lateral forces do not occur when it operates. These could result in the guide and sealing components suffering premature wear which may lead to failure of the volumetric divider.

## Commissioning

Before connecting the multi-chamber volumetric divider it is necessary to flush through the pipe system. Information (with wiring diagram) on how to fill and evacuate air from the multi-chamber volumetric divider in conjunction with the manifolds is provided from page 18 onwards.

## Maintenance

The simple design of the multi-chamber volumetric divider ensures very reliable operation combined with minimum maintenance that is limited mainly to a periodic control of any potential leakage losses.

It is essential to check that the oil is clean with respect to the pressure limit and non-return valves. Swarf may often be present in the system particularly when at the time it is first started. Having successfully filled the system, it should operate synchronously. If it does not, it will be necessary to check the above valves for particulate.



# Multi-chamber volumetric-divider MZB 050

Circuit according DIN ISO 1219

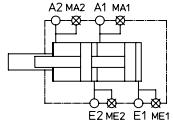

**MZB-2-050-....-SR**

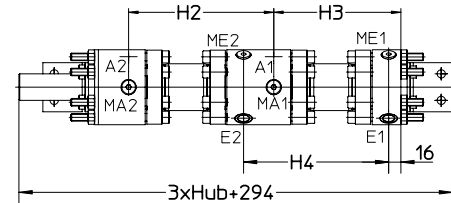
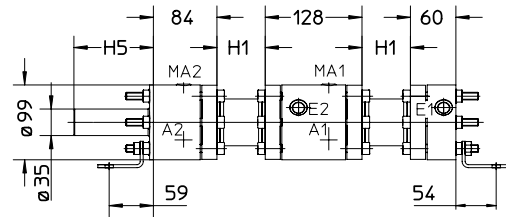
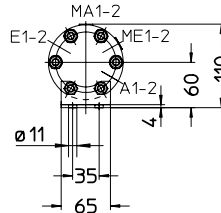

- E1-E2 G3/8" input, connections are joined each other
- A1-A2 G3/8" output, part flows
- ME1-ME2 G1/4" measurement connections or for evacuation of air, input
- MA1-MA2 G1/4" measurement connections or for evacuation of air, output

H1	H2	H3	H4	H5
stroke - 36	stroke + 92	stroke + 68	stroke + 92	stroke + 25

Circuit according DIN ISO 1219

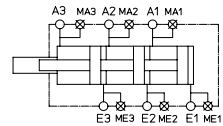

**MZB-3-050-....-SR**

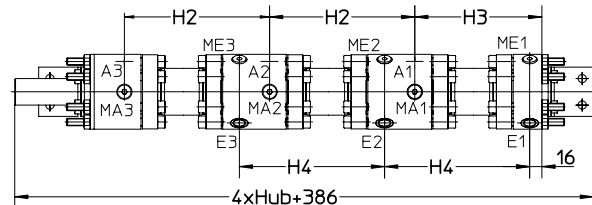
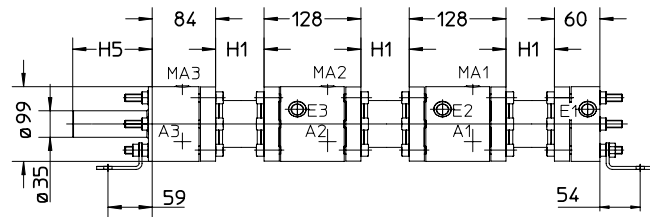
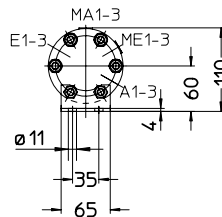

- E1-E3 G3/8" input, connections are joined each other
- A1-A3 G3/8" output, part flows
- ME1-ME3 G1/4" measurement connections or for evacuation of air, input
- MA1-MA3 G1/4" measurement connections or for evacuation of air, output

H1	H2	H3	H4	H5
stroke - 36	stroke + 92	stroke + 68	stroke + 92	stroke + 25

Circuit according DIN ISO 1219

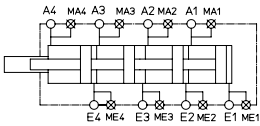

**MZB-4-050-....-SR**

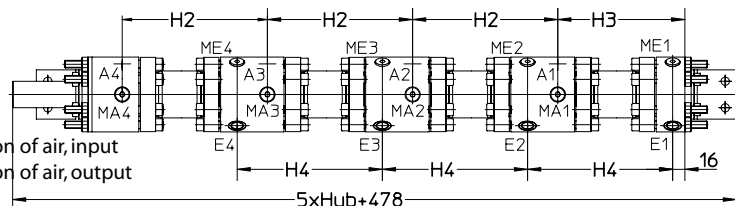
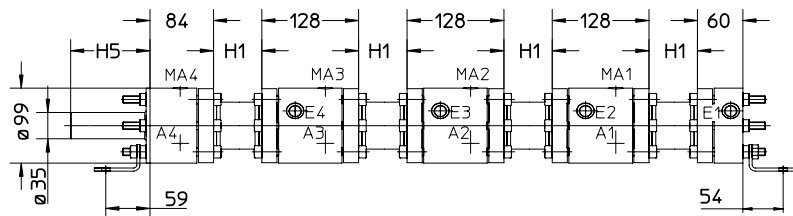
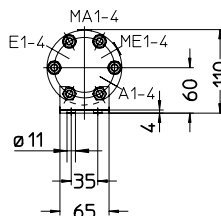

- E1-E4 G3/8" input, connections are joined each other
- A1-A4 G3/8" output, part flows
- ME1-ME4 G1/4" measurement connections or for evacuation of air, input
- MA1-MA4 G1/4" measurement connections or for evacuation of air, output

H1	H2	H3	H4	H5
stroke - 36	stroke + 92	stroke + 68	stroke + 92	stroke + 25

# Multi-chamber volumetric-divider **MZB 080**

<b>MZB</b>		050	080	140	180	220	280
Stroke min	mm	100	130	150	200	250	300
Stroke max	mm	1200	1200	1200	1200	1200	1200
Chamber volume min*	cm <sup>3</sup>	158,3	489,6	2.070,4	4.523,8	8.246,5	16.563,9
Chamber volume max*	cm <sup>3</sup>	1.900,0	4.523,9	16.564,0	27.143,3	39.584,0	66.255,6
Piston Ø	mm	50	80	140	180	220	280
Piston rod Ø	mm	22	40	45	60	80	90
Area	cm <sup>2</sup>	15,83	37,69	138,03	226,19	329,86	552,13
Oil flow max	l/min	30	60	90	150	220	300
*per chamber	max. operating pressure 250 bar, higher pressure on request						

Drawing for 2-12 fold MZB on request, also DXF or Step.

## Order-code

Example: **MZB-6-080-0250-V-DMS**

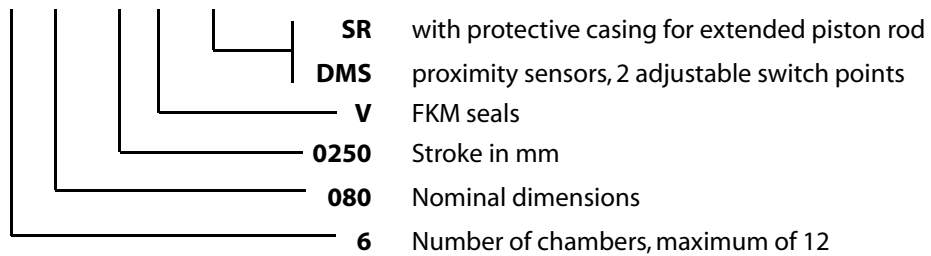

## MZB-..-080-...-DMS

Moveable proximity sensors fitted into protective casing, or minimum and maximum position, additional switch points possible.

Circuit according DIN ISO 1219

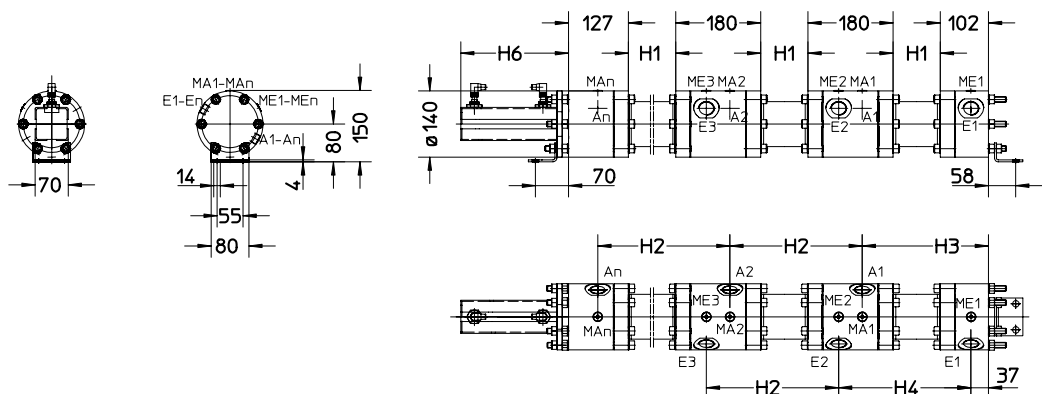
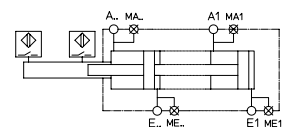

H1	H2	H3	H4	H6
stroke - 48	stroke + 132	stroke + 119	stroke + 132	stroke + 80



# Multi-chamber volumetric-divider MZB 080

Circuit according DIN ISO 1219

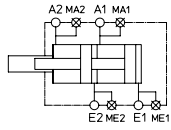

**MZB-2-080-....-SR**

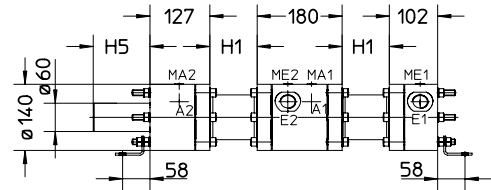
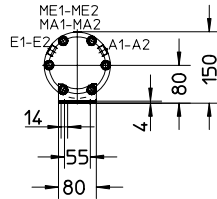

- E1-E2 G1/2" input, connections are joined each other
- A1-A2 G1/2" output, part flows
- ME1-ME2 G1/4" measurement connections or for evacuation of air, input
- MA1-MA2 G1/4" measurement connections or for evacuation of air, output

H1	H2	H3	H4	H5
stroke - 48	stroke + 132	stroke + 119	stroke + 132	stroke + 20

Circuit according DIN ISO 1219

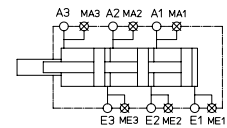

**MZB-3-080-....-SR**

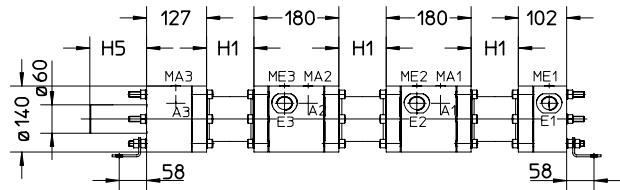
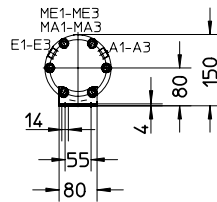

- E1-E3 G1/2" input, connections are joined each other
- A1-A3 G1/2" output, part flows
- ME1-ME3 G1/4" measurement connections or for evacuation of air, input
- MA1-MA3 G1/4" measurement connections or for evacuation of air, output

H1	H2	H3	H4	H5
stroke - 48	stroke + 132	stroke + 119	stroke + 132	stroke + 20

Circuit according DIN ISO 1219

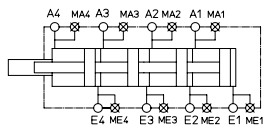

**MZB-4-080-....-SR**

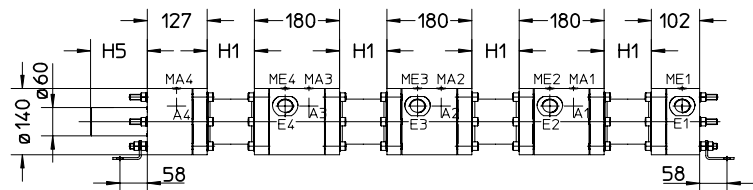
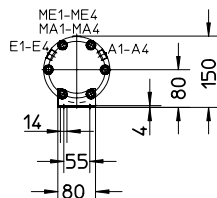

- E1-E4 G1/2" input, connections are joined each other
- A1-A4 G1/2" output, part flows
- ME1-ME4 G1/4" measurement connections or for evacuation of air, input
- MA1-MA4 G1/4" measurement connections or for evacuation of air, output

H1	H2	H3	H4	H5
stroke - 48	stroke + 132	stroke + 119	stroke + 132	stroke + 20

# Multi-chamber volumetric-divider **MZB 140**

<b>MZB</b>		050	080	140	180	220	280
Stroke min	mm	100	130	150	200	250	300
Stroke max	mm	1200	1200	1200	1200	1200	1200
Chamber volume min*	cm <sup>3</sup>	158,3	489,6	2.070,4	4.523,8	8.246,5	16.563,9
Chamber volume max*	cm <sup>3</sup>	1.900,0	4.523,9	16.564,0	27.143,3	39.584,0	66.255,6
Piston Ø	mm	50	80	140	180	220	280
Piston rod Ø	mm	22	40	45	60	80	90
Area	cm <sup>2</sup>	15,83	37,69	138,03	226,19	329,86	552,13
Oil flow max	l/min	30	60	90	150	220	300
*per chamber	max. operating pressure 250 bar, higher pressure on request						

Drawing for 2-12 fold MZB on request, also DXF or Step.

## Order-code

Example: **MZB-6-140-0250-V-DMS**

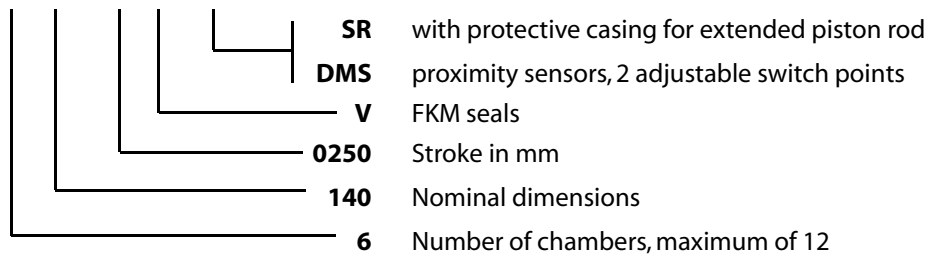

## MZB-..-140-...-DMS

Moveable proximity sensors fitted into protective casing, or minimum and maximum position, additional switch points possible.

Circuit according DIN ISO 1219

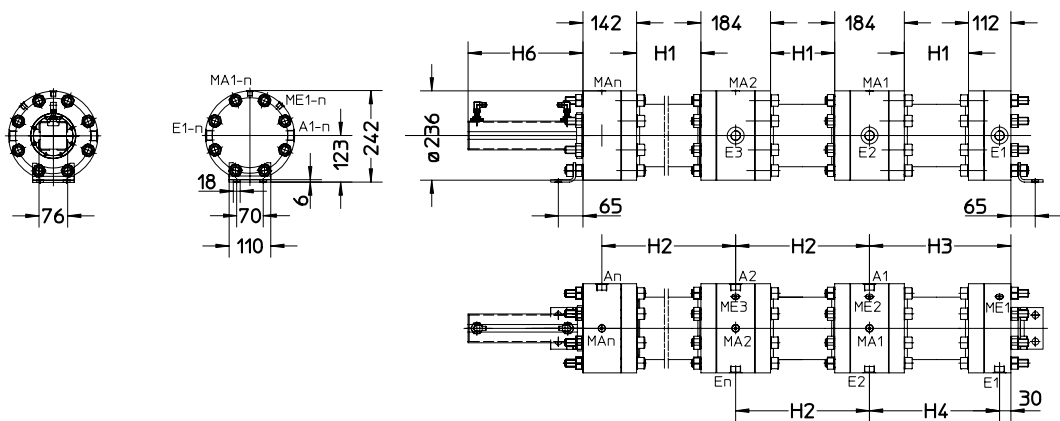
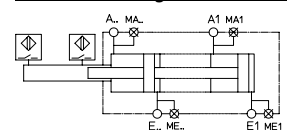

H1	H2	H3	H4	H6
stroke - 69	stroke + 115	stroke + 135	stroke + 105	stroke + 65

# Multi-chamber volumetric-divider MZB 140

Circuit according DIN ISO 1219

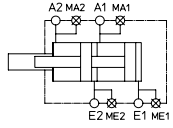

**MZB-2-140-....-SR**

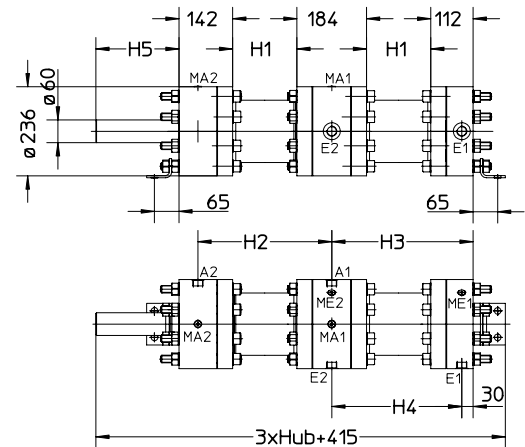
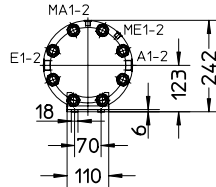

- E1-E2 G3/4" input, connections are joined each other
- A1-A2 G3/4" output, part flows
- ME1-ME2 G1/4" measurement connections or for evacuation of air, input
- MA1-MA2 G1/4" measurement connections or for evacuation of air, output

H1	H2	H3	H4	H5
stroke - 69	stroke + 115	stroke + 135	stroke + 105	stroke + 30

Circuit according DIN ISO 1219

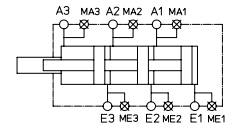

**MZB-3-140-....-SR**

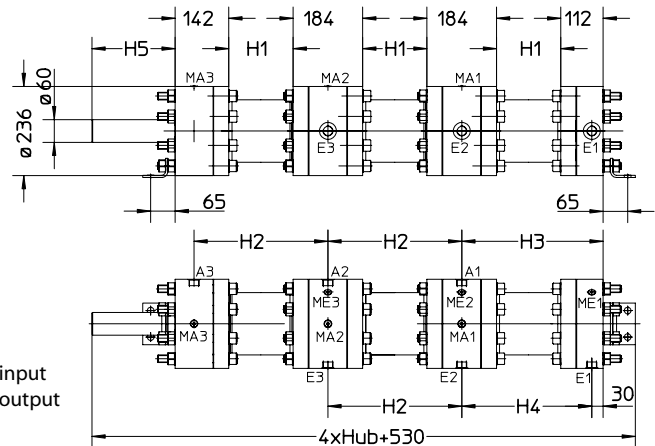
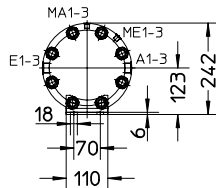

- E1-E3 G3/4" input, connections are joined each other
- A1-A3 G3/4" output, part flows
- ME1-ME3 G1/4" measurement connections or for evacuation of air, input
- MA1-MA3 G1/4" measurement connections or for evacuation of air, output

H1	H2	H3	H4	H5
stroke - 69	stroke + 115	stroke + 135	stroke + 105	stroke + 30

Circuit according DIN ISO 1219

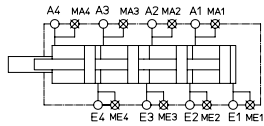

**MZB-4-140-....-SR**

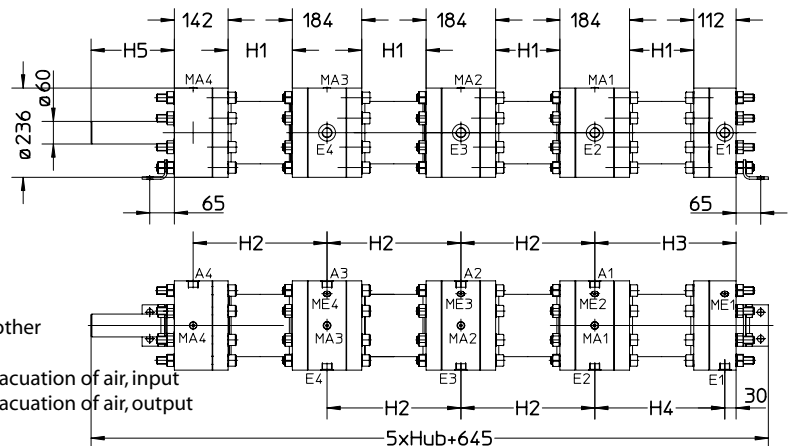
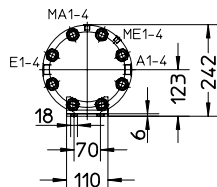

- E1-E4 G3/4" input, connections are joined each other
- A1-A4 G3/4" output, part flows
- ME1-ME4 G1/4" measurement connections or for evacuation of air, input
- MA1-MA4 G1/4" measurement connections or for evacuation of air, output

H1	H2	H3	H4	H5
stroke - 69	stroke + 115	stroke + 135	stroke + 105	stroke + 30

# Multi-chamber volumetric-divider **MZB 180**

<b>MZB</b>		050	080	140	180	220	280
Stroke min	mm	100	130	150	200	250	300
Stroke max	mm	1200	1200	1200	1200	1200	1200
Chamber volume min*	cm <sup>3</sup>	158,3	489,6	2.070,4	4.523,8	8.246,5	16.563,9
Chamber volume max*	cm <sup>3</sup>	1.900,0	4.523,9	16.564,0	27.143,3	39.584,0	66.255,6
Piston Ø	mm	50	80	140	180	220	280
Piston rod Ø	mm	22	40	45	60	80	90
Area	cm <sup>2</sup>	15,83	37,69	138,03	226,19	329,86	552,13
Oil flow max	l/min	30	60	90	150	220	300
*per chamber	max. operating pressure 250 bar, higher pressure on request						

Drawing for 2-12 fold MZB on request, also DXF or Step.

## Order-code

Example: **MZB-6-180-0250-V-DMS**

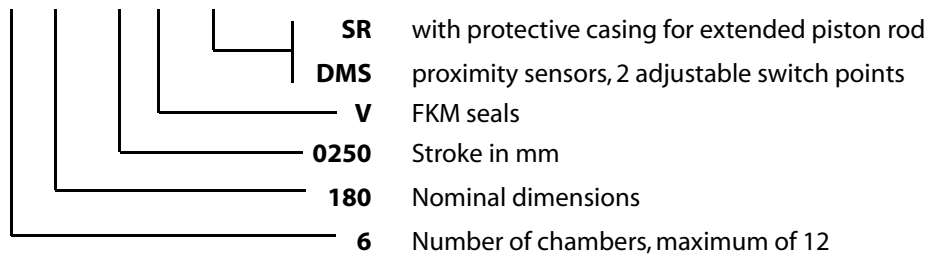

## MZB-..-180-...-DMS

Moveable proximity sensors fitted into protective casing, or minimum and maximum position, additional switch points possible.

Circuit according DIN ISO 1219

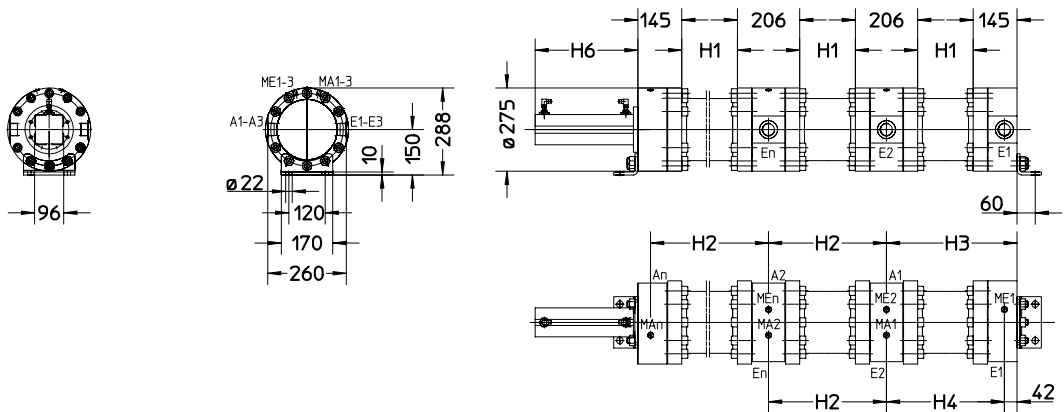
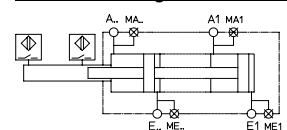

H1	H2	H3	H4	H6
stroke - 66	stroke + 140	stroke + 182	stroke + 140	stroke + 90

# Multi-chamber volumetric-divider MZB 180

Circuit according DIN ISO 1219

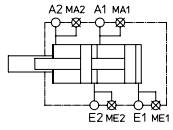

**MZB-2-180-....-SR**

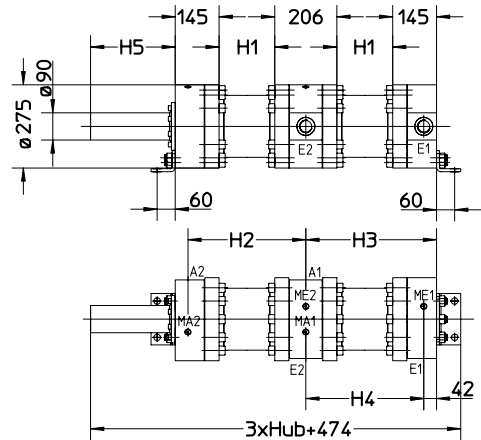
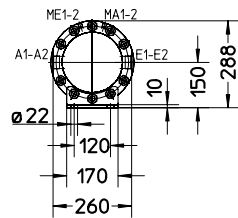

- E1-E2 G1 1/4" input, connections are joined each other
- A1-A2 G1 1/4" output, part flows
- ME1-ME2 G1/4" measurement connections or for evacuation of air, input
- MA1-MA2 G1/4" measurement connections or for evacuation of air, output

H1	H2	H3	H4	H5
stroke - 66	stroke + 140	stroke + 182	stroke + 140	stroke + 30

Circuit according DIN ISO 1219

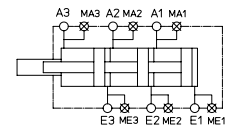

**MZB-3-180-....-SR**

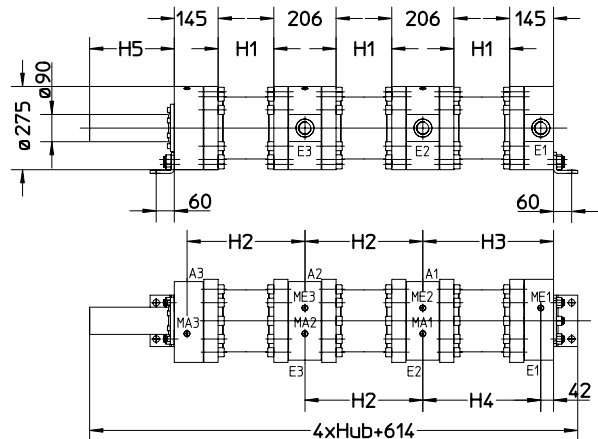
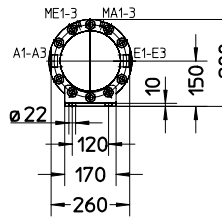

- E1-E3 G1 1/4" input, connections are joined each other
- A1-A3 G1 1/4" output, part flows
- ME1-ME3 G1/4" measurement connections or for evacuation of air, input
- MA1-MA3 G1/4" measurement connections or for evacuation of air, output

H1	H2	H3	H4	H5
stroke - 66	stroke + 140	stroke + 182	stroke + 140	stroke + 30

Circuit according DIN ISO 1219

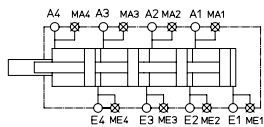

**MZB-4-180-....-SR**

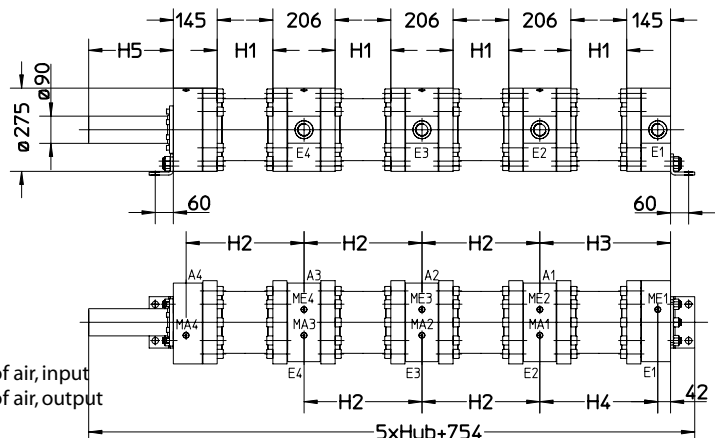
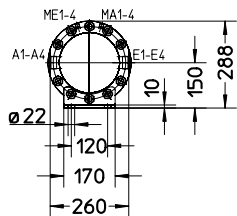

- E1-E4 G1 1/4" input, connections are joined each other
- A1-A4 G1 1/4" output, part flows
- ME1-ME4 G1/4" measurement connections or for evacuation of air, input
- MA1-MA4 G1/4" measurement connections or for evacuation of air, output

H1	H2	H3	H4	H5
stroke - 66	stroke + 140	stroke + 182	stroke + 140	stroke + 30



# Multi-chamber volumetric-divider MZB 220

Circuit according DIN ISO 1219

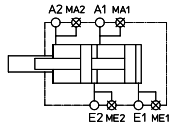

**MZB-2-220-....-SR**

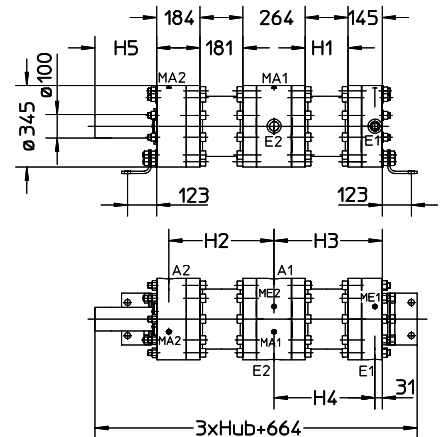
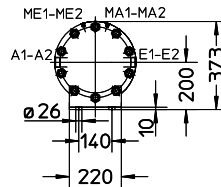

- E1-E2 G1 1/4" input, connections are joined each other
- A1-A2 G1 1/4" output, part flows
- ME1-ME2 G1/4" measurement connections or for evacuation of air, input
- MA1-MA2 G1/4" measurement connections or for evacuation of air, output

H1	H2	H3	H4	H5
stroke - 69	stroke + 195	stroke + 208	stroke + 177	stroke + 61

Circuit according DIN ISO 1219

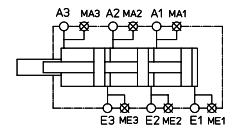

**MZB-3-220-....-SR**

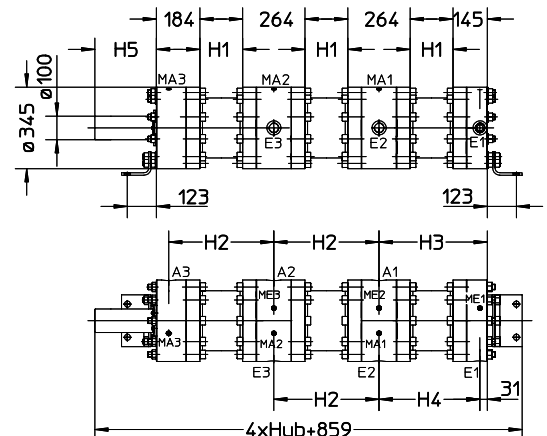
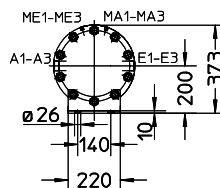

- E1-E3 G1 1/4" input, connections are joined each other
- A1-A3 G1 1/4" output, part flows
- ME1-ME3 G1/4" measurement connections or for evacuation of air, input
- MA1-MA3 G1/4" measurement connections or for evacuation of air, output

H1	H2	H3	H4	H5
stroke - 69	stroke + 195	stroke + 208	stroke + 177	stroke + 61

Circuit according DIN ISO 1219

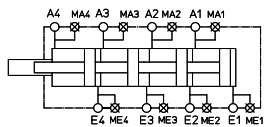

**MZB-4-220-....-SR**

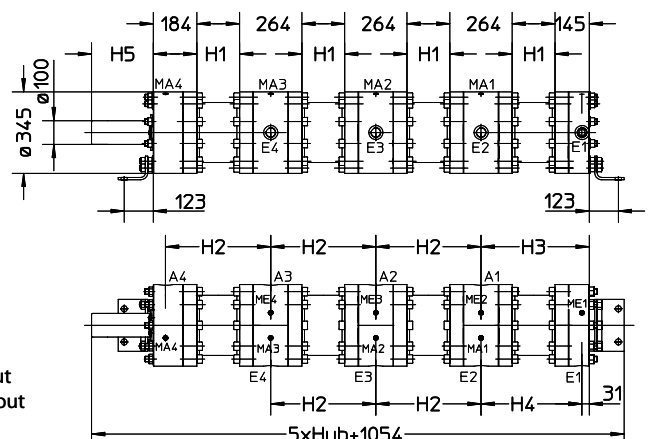
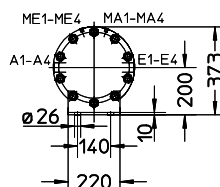

- E1-E4 G1 1/4" input, connections are joined each other
- A1-A4 G1 1/4" output, part flows
- ME1-ME4 G1/4" measurement connections or for evacuation of air, input
- MA1-MA4 G1/4" measurement connections or for evacuation of air, output

H1	H2	H3	H4	H5
stroke - 69	stroke + 195	stroke + 208	stroke + 177	stroke + 61

# Multi-chamber volumetric-divider **MZB 280**

<b>MZB</b>		050	080	140	180	220	280
Stroke min	mm	100	130	150	200	250	300
Stroke max	mm	1200	1200	1200	1200	1200	1200
Chamber volume min*	cm <sup>3</sup>	158,3	489,6	2.070,4	4.523,8	8.246,5	16.563,9
Chamber volume max*	cm <sup>3</sup>	1.900,0	4.523,9	16.564,0	27.143,3	39.584,0	66.255,6
Piston Ø	mm	50	80	140	180	220	280
Piston rod Ø	mm	22	40	45	60	80	90
Area	cm <sup>2</sup>	15,83	37,69	138,03	226,19	329,86	552,13
Oil flow max	l/min	30	60	90	150	220	300
*per chamber	max. operating pressure 250 bar, higher pressure on request						

Drawing for 2-12 fold MZB on request, also DXF or Step.

## Order-code

Example: **MZB-6-280-0500-V-DMS**

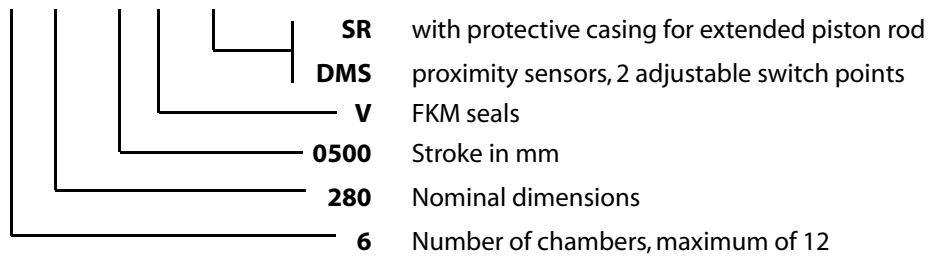

## MZB-..-280-....-DMS

Moveable proximity sensors fitted into protective casing, or minimum and maximum position, additional switch points possible.

Circuit according DIN ISO 1219

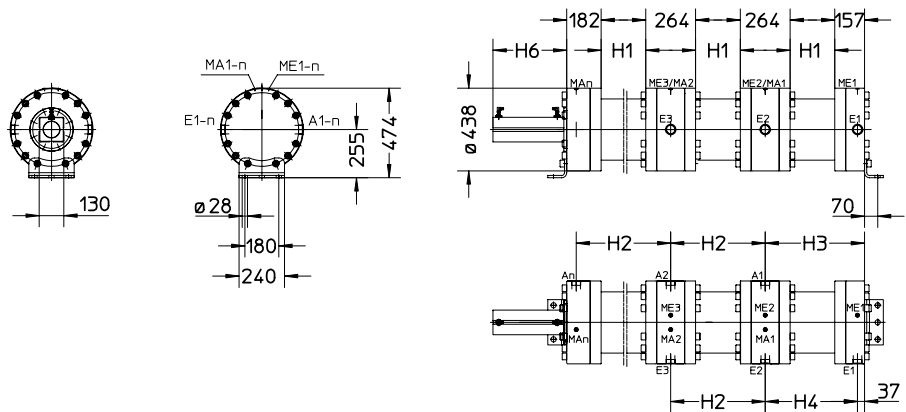
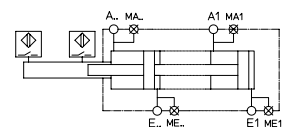

H1	H2	H3	H4	H6
stroke - 64	stroke + 200	stroke + 225	stroke + 188	stroke + 90



# Multi-chamber volumetric-divider MZB 280

Circuit according DIN ISO 1219

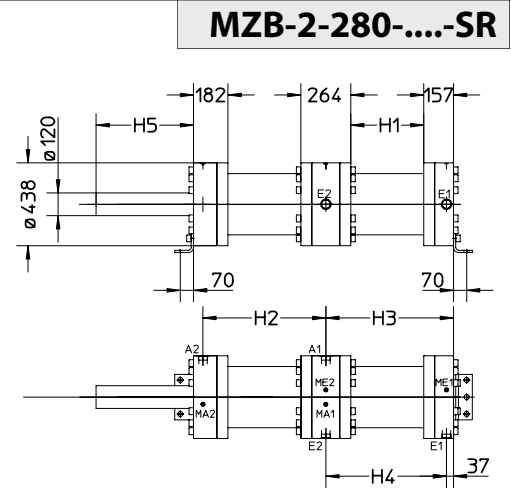
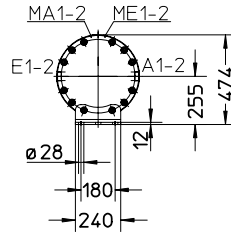
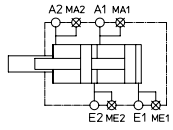

- E1-E2 G1 1/4" input, connections are joined each other
- A1-A2 G1 1/4" output, part flows
- ME1-ME2 G1/4" measurement connections or for evacuation of air, input
- MA1-MA2 G1/4" measurement connections or for evacuation of air, output

H1	H2	H3	H4	H5
stroke - 64	stroke + 200	stroke + 225	stroke + 188	stroke + 65

Circuit according DIN ISO 1219

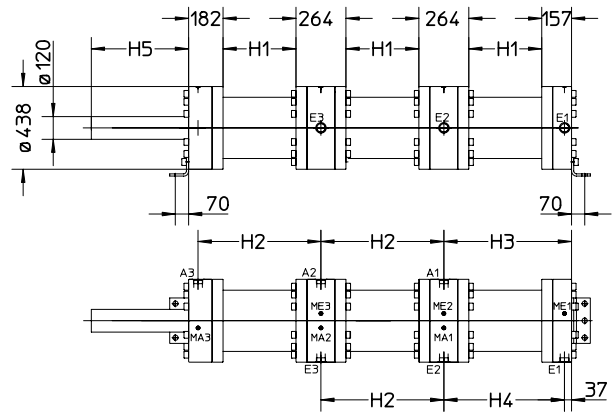
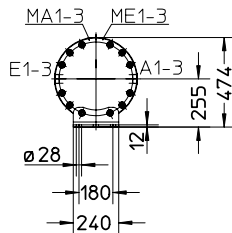
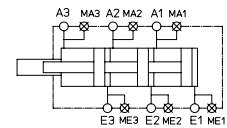

- E1-E3 G1 1/4" input, connections are joined each other
- A1-A3 G1 1/4" output, part flows
- ME1-ME3 G1/4" measurement connections or for evacuation of air, input
- MA1-MA3 G1/4" measurement connections or for evacuation of air, output

H1	H2	H3	H4	H5
stroke - 64	stroke + 200	stroke + 225	stroke + 188	stroke + 65

Circuit according DIN ISO 1219

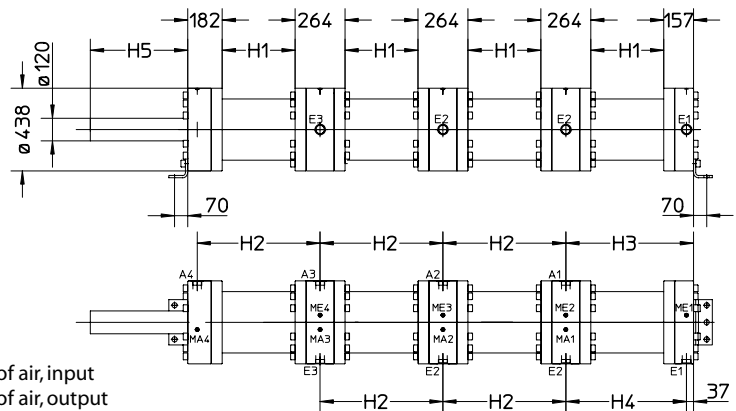
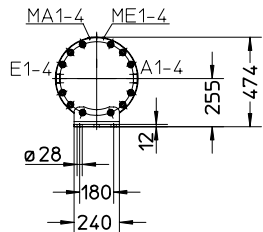
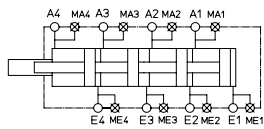

- E1-E4 G1 1/4" input, connections are joined each other
- A1-A4 G1 1/4" output, part flows
- ME1-ME4 G1/4" measurement connections or for evacuation of air, input
- MA1-MA4 G1/4" measurement connections or for evacuation of air, output

H1	H2	H3	H4	H5
stroke - 64	stroke + 200	stroke + 225	stroke + 188	stroke + 65

# Manifold B29

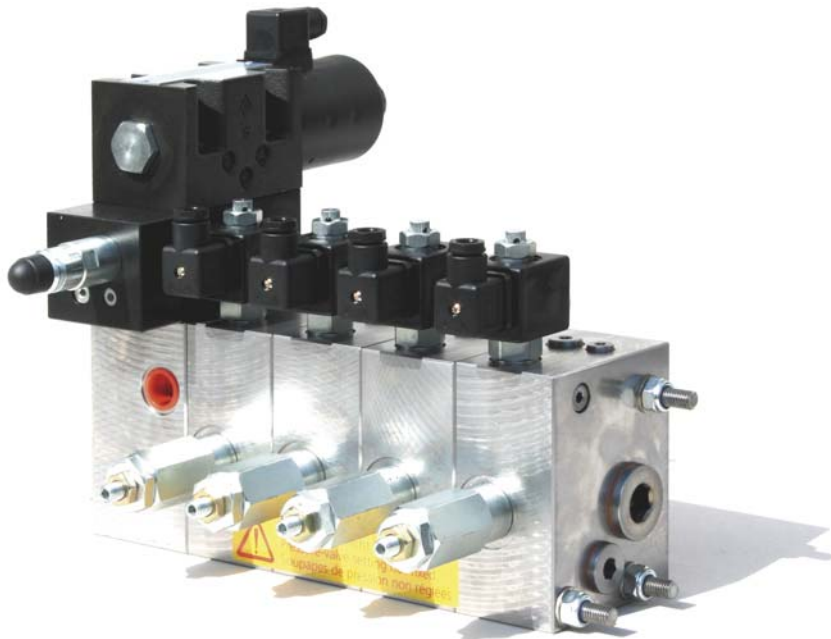

## Order-code

Example: **B29-4-140-NG6-V**

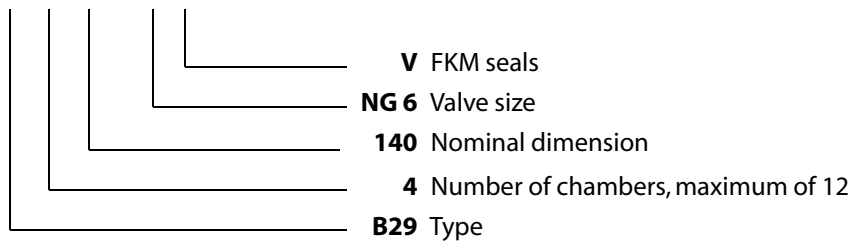

Circuit according DIN ISO 1219

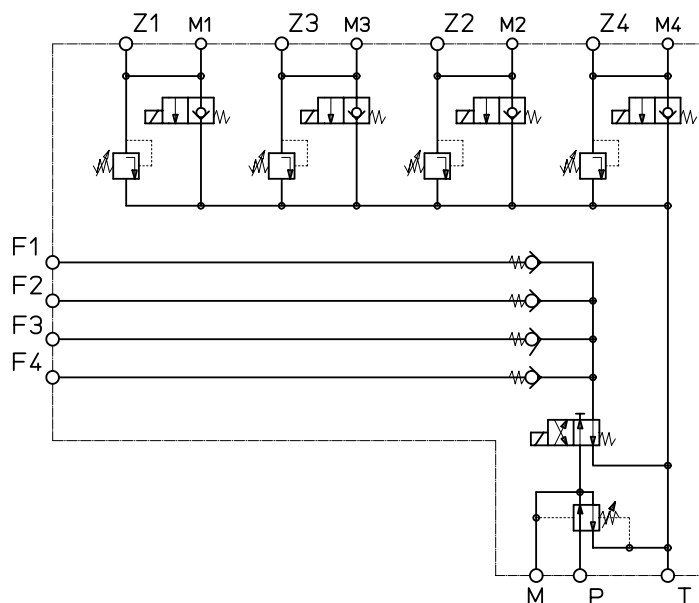

# Manifold B29

- P** G1/2" Pressure connection
- T** G1" Tank connection
- F** G1/2" Filling connections, multi-chamber volumetric divider
- Z** G3/4" Connections, operating cylinders
- M** G1/4" Measurement connections

**B29-4-140-NG6**

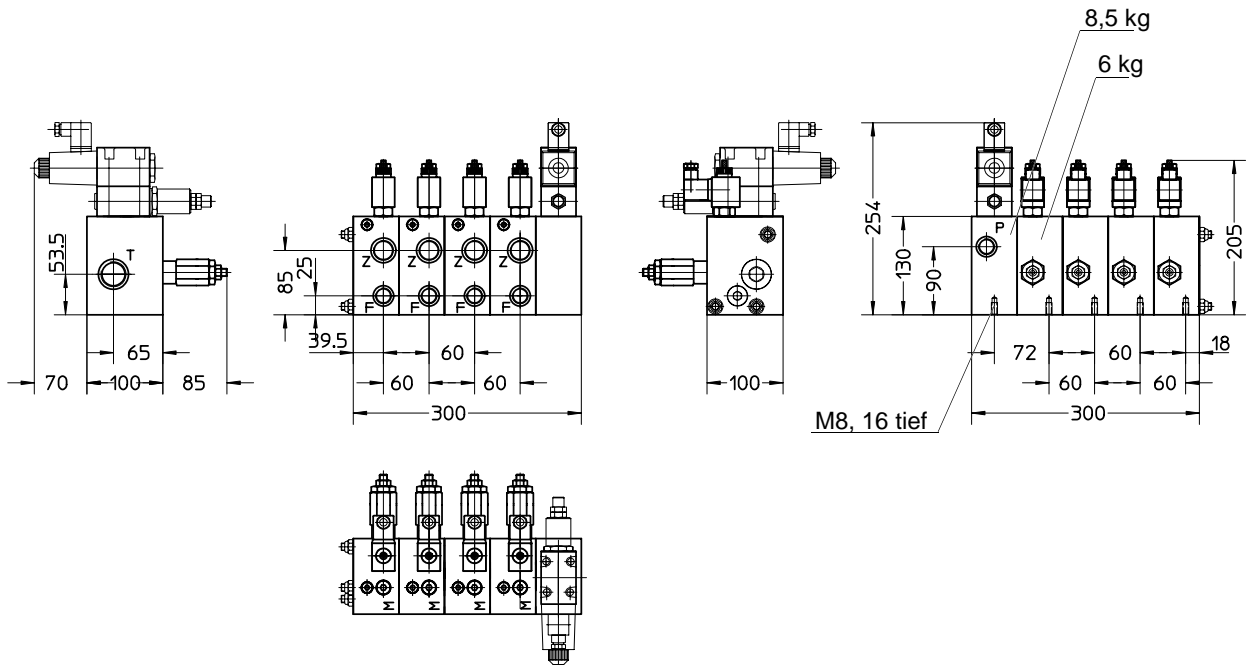

- P** G1/2" Pressure connection
- T** G1" Tank connection
- F** G1/2" Filling connections, multi-chamber volumetric divider
- Z** G3/4" Connections, operating cylinders
- M** G1/4" Measurement connections

**B29-4-140-NG10**

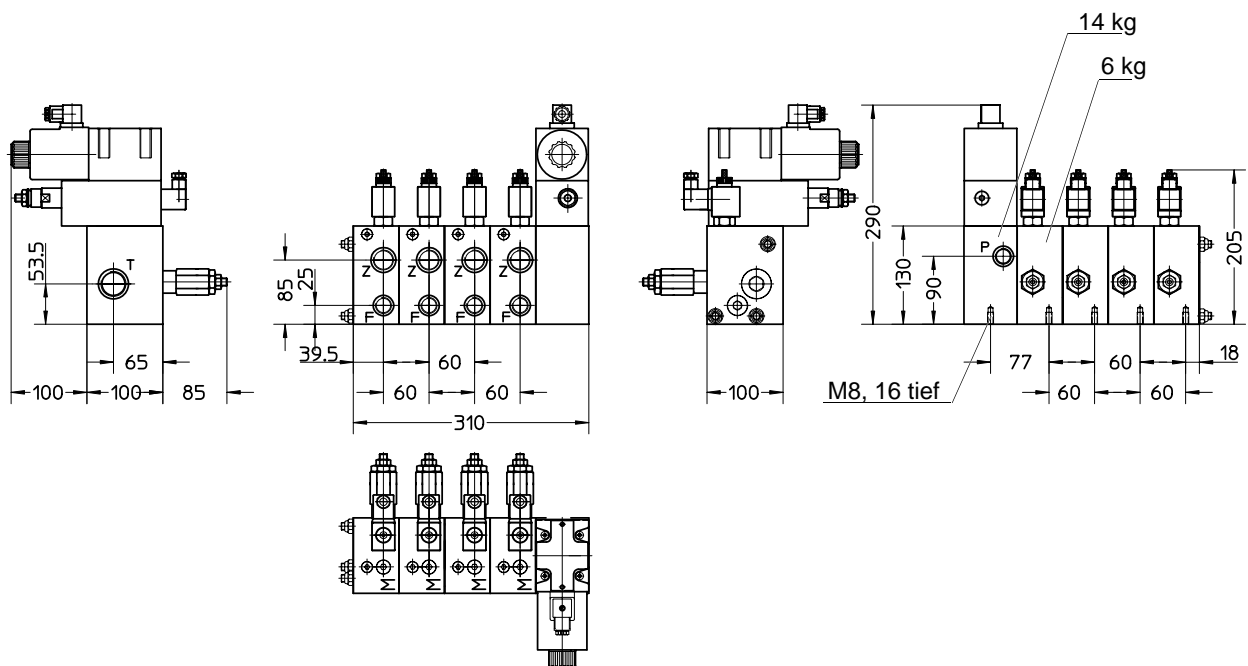

# Multi-chamber volumetric-divider with manifold B29

**Filling and evacuating** air from the empty pipes between the multi-chamber volumetric divider and the operating cylinders.

1. Drive the operating cylinder to the lower end limit position using the 4/3 directional control valve **1** (Y11 switched) Leave the operating cylinders **10** under pressure and evacuate the air on the piston side by means of the bleed screw or by opening the threaded fitting.
2. Switch the 4/3 directional control valve **1** to off position (valve in middle position).
3. Set the pressure reducing valve **4** on manifold B29 to the lowest pressure.
4. Switch the 4/2 directional control valve **5** on manifold B29 and at the pressure reducing valve **4** increase the pressure only to the point at which the operating cylinders **10** are about to move and then set it to a just under this value. However the pressure must be so high that the multi-chamber volumetric divider can be driven reliably to its end limit position. If this is not the case, a pilot operated check valve must be fitted in the 'B' connection of valve **1**. This setting also applies to the so-called 'reset' i.e. filling the oil between multi-chamber volumetric divider and operating cylinders.
5. This fills the connecting pipes between the multi-chamber volumetric divider and the operating cylinders **10** and the multi-chamber volumetric divider **3** should then move to the end limit position.
6. Evacuate air through the test ports **MA** on the multi-chamber volumetric divider **3** and/or the connections to the operating cylinders **10** on the piston side.
7. Drive the operating cylinders **10** using the 4/3 directional control valve **1** (Y12 switched) and the multi-chamber volumetric divider to the end limit position and evacuate air from the connecting pipes via the test ports **ME**.
8. Drive the operating cylinders several times to both end limit positions by switching the 4/3 directional control valve **1**.
9. As described under point 4 and 6 refill the pipes between the multi-chamber volumetric divider **3** and the operating cylinders **10** via the 4/2 directional control valve **5** on manifold B29 and evacuate air until the operating cylinders move in the required synchronisation.

## Pressure limit valves

The pressure limit valves **7** can be set to the maximum operating pressure of the operating cylinders **10** plus around 20 bar, however no higher than the maximum operating pressure of the multi-chamber volumetric divider installed (standard operating pressure 250 bar).

**'Resetting' the oil volume** between multi-chamber volumetric divider and the operating cylinders.

1. The 4/3 directional control valve **1** is in the middle position. The operating cylinders **10** are in the lower end limit position. The multi-chamber volumetric divider **3** is not yet in its end limit position.
2. By switching the 4/2 directional control valve **5** the connecting pipes between the multi-chamber volumetric divider and the operating cylinders **10** are filled and multi-chamber volumetric divider is driven to its end limit position.

**Changing the oil** between the multi-chamber volumetric divider and the operating cylinders. Since the oil is only moved between the multi-chamber volumetric divider and the operating cylinders it is necessary to change the oil on a regular basis depending on the switching frequency, operating pressure and ambient temperature. The oil temperature in these connecting pipes can be taken as a gauge. It should not be greater than 80°C. To facilitate a quick oil change the **F** connections must be connected as close to the multi-chamber volumetric divider **3** as possible and the **Z** connections as close as possible to the operating cylinders.

1. The 4/3 directional control valve **1** is in the middle position. The operating cylinders **10** are in the lower end limit position
2. Open the 2/2 directional control valves **8**.
3. By switching the 4/2 directional control valve **5** the oil in the connecting pipes between the multi-chamber volumetric divider and the operating cylinders **10** is replaced in part.
4. Close the 2/2 directional control valves **8**.
5. The connecting pipes between the multi-chamber volumetric divider **3** and the operating cylinders **10** are filled through 4/2 directional control valve **5** that is still open and the multi-chamber volumetric divider should then move to its end position.

# Hydraulic diagram

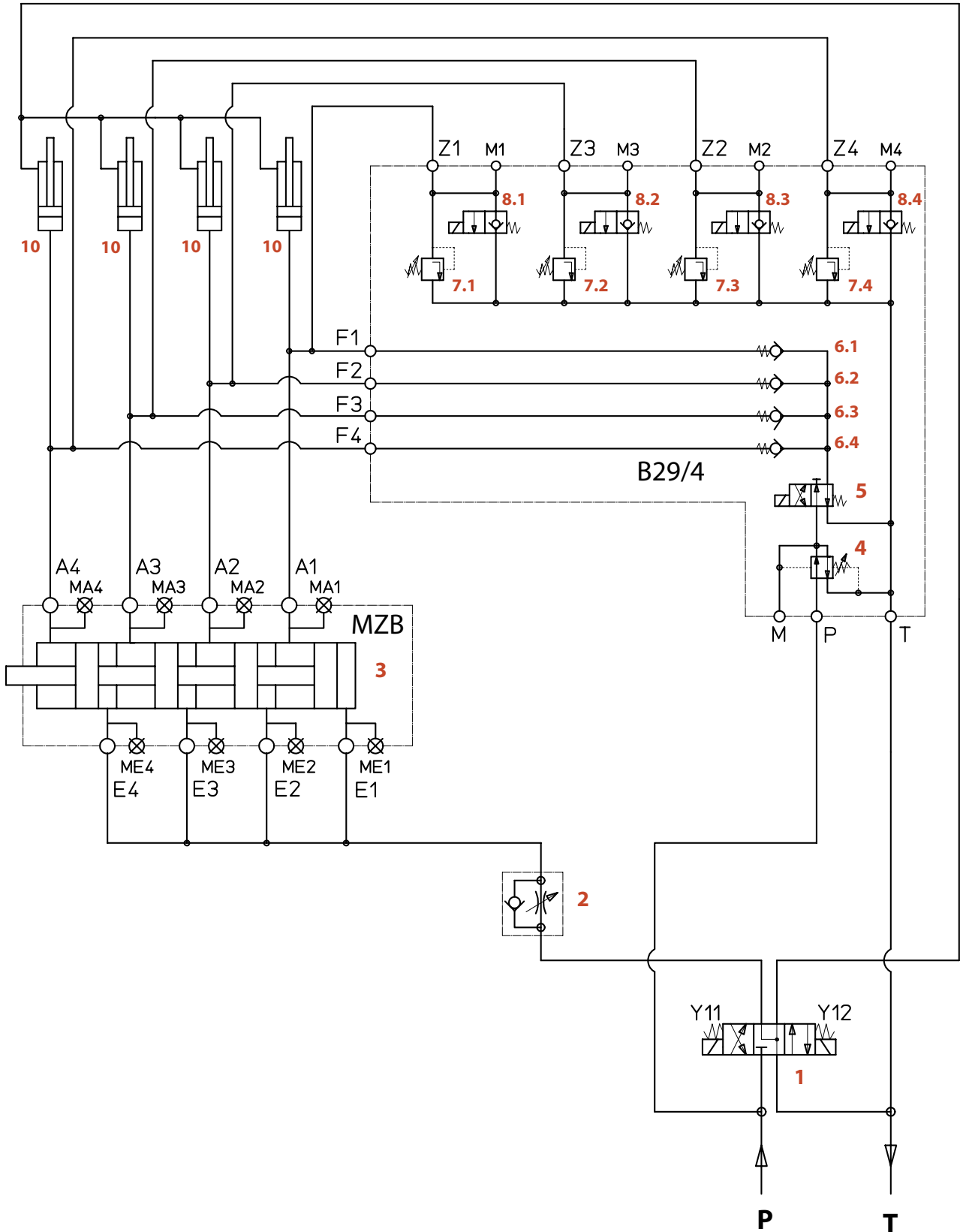

# Components for hydraulics and process technology

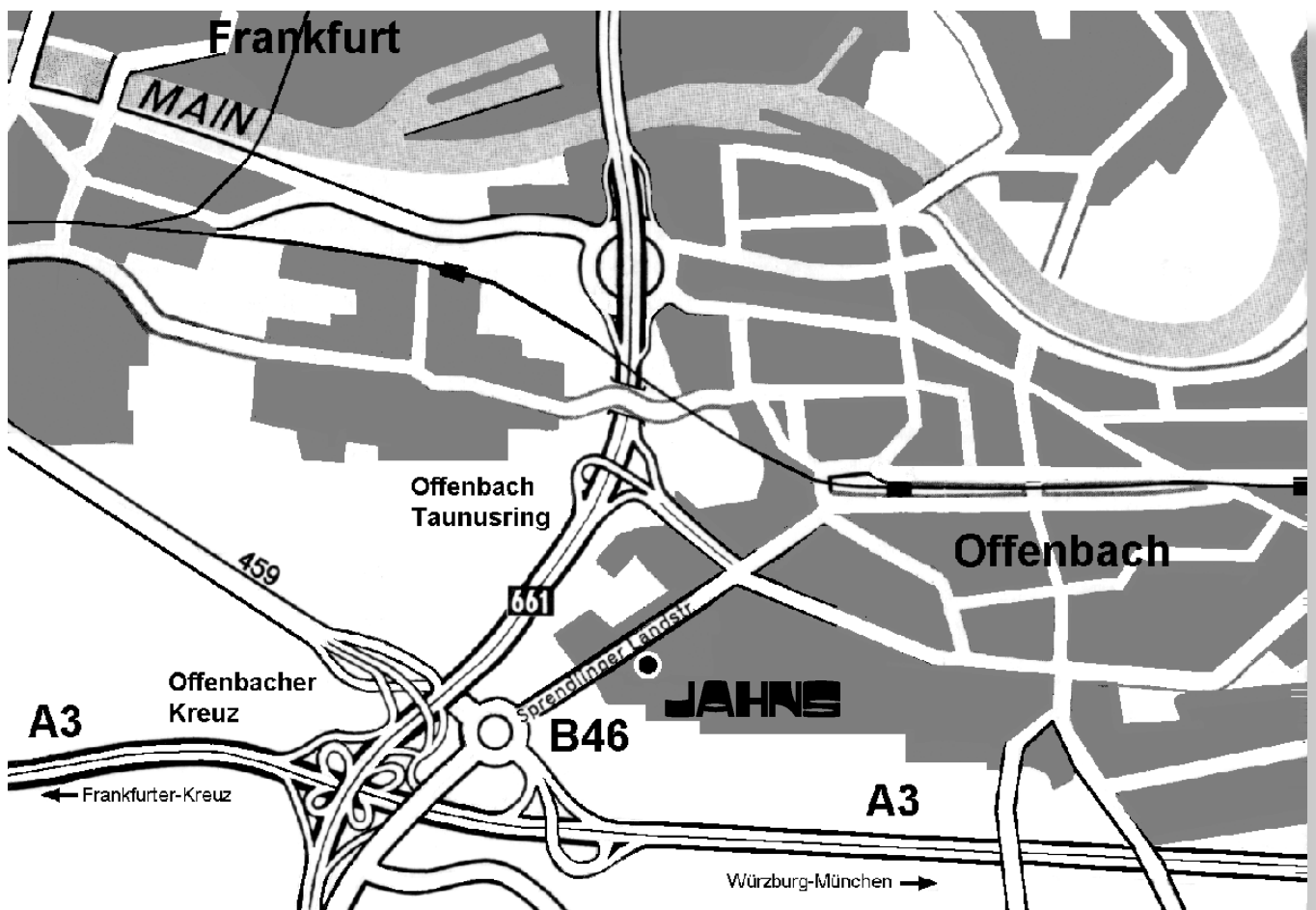

**Jahns-Regulatoren GmbH**  
Postbox 10 09 52  
D 63009 Offenbach  
telephon +49/(0)69/84 84 77-0

home address  
Sprendlinger Landstraße 150  
D 63069 Offenbach  
telefax +49/(0)69/84 84 77 25

<http://www.jahns-hydraulik.de>  
[info@jahns-hydraulik.de](mailto:info@jahns-hydraulik.de)